

----- Isabelle -----

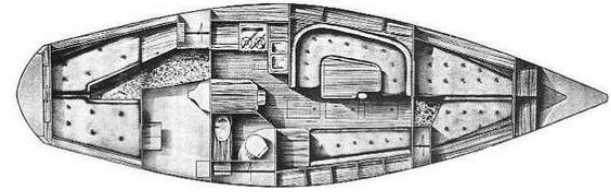
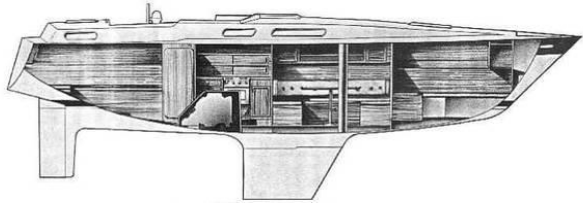

Scanmar 35 # 68

Built in Ornskoldsvik, Sweden 1985

100 where built and approximately 20 where exported to the US.

All sold at the Polarus Marina, Rock Hall MD

Specifications

1. General

| | | |
|--|--|----------------------|
| a. LOA..... |  | 10,70 m (35,1 ft) |
| b. LVL | | 8,40 m (27,5 ft) |
| c. Beam | | 3,30 m (10,8 ft) |
| d. Draft keel | | 1,77 m (5,8 ft) |
| e. Total Weight | | 5 400 kg (11 900lbs) |
| f. Keel Weight | | 1 890 kg (4 165 lbs) |
| g. Height (Vertical Clearance)..... | | 15,40 m (50,5 ft) |
| h. LYS SVG (Spinnaker,Folding,G1)..... | | 1,14 |
| i. DH-88 | | 6,45 |
| j. TA2000 | | 710 |

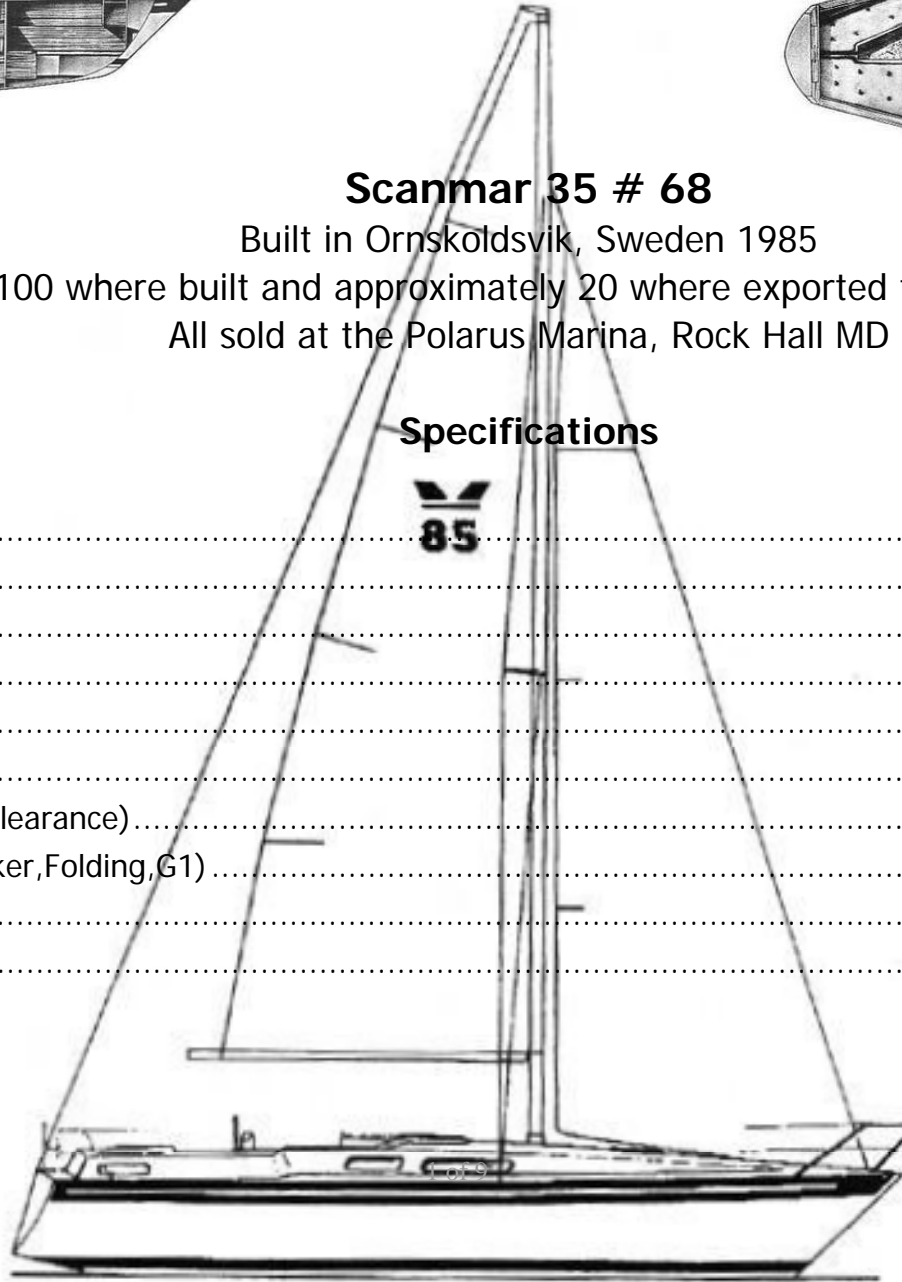

----- Isabelle -----

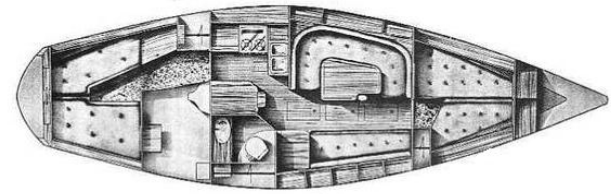
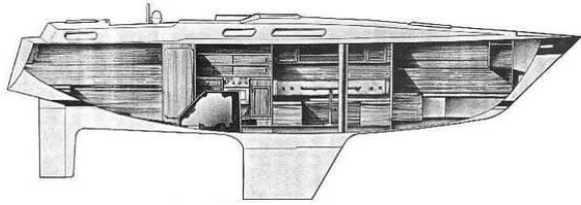

2. Sail measurements

| | |
|-------------|--------------------|
| a. P..... | 12,55 m (41,17 ft) |
| b. E..... | 3,70 m (12,14 ft) |
| c. T..... | 12,10 m (39,69 ft) |
| d. LP..... | 5,70 m (18,70 ft) |
| e. J..... | 3,80 m (12,46 ft) |
| f. SL..... | 11,95 m (39,20 ft) |
| g. SBR..... | 6,84 m (22,44 ft) |
| h. SPL..... | 3,80 m (12,46 ft) |

3. Propulsion

| | |
|-------------------------------------|---|
| a. Volvo Penta D1-30A/MS10A-B | 28,4 Hp (20.9 kW) ISO8655 |
| b. Weight | 138 kg (304 lbs) |
| c. Cylinders | 3 |
| d. Norm/Max rpm..... | 2800/3200 rpm |
| e. Engine Oil..... | 3,5 lit (1,03 US gallons) |
| f. Gearbox Oil..... | 0,35 lit (0,09 US gallons) |
| g. Cooling system..... | 4,0 lit (1,05 US Gallons) |
| h. Displacement | 1130 ccm ³ (68,1 inch ³) |
| i. Gearbox Reduction Ratio..... | 2,35:1 |

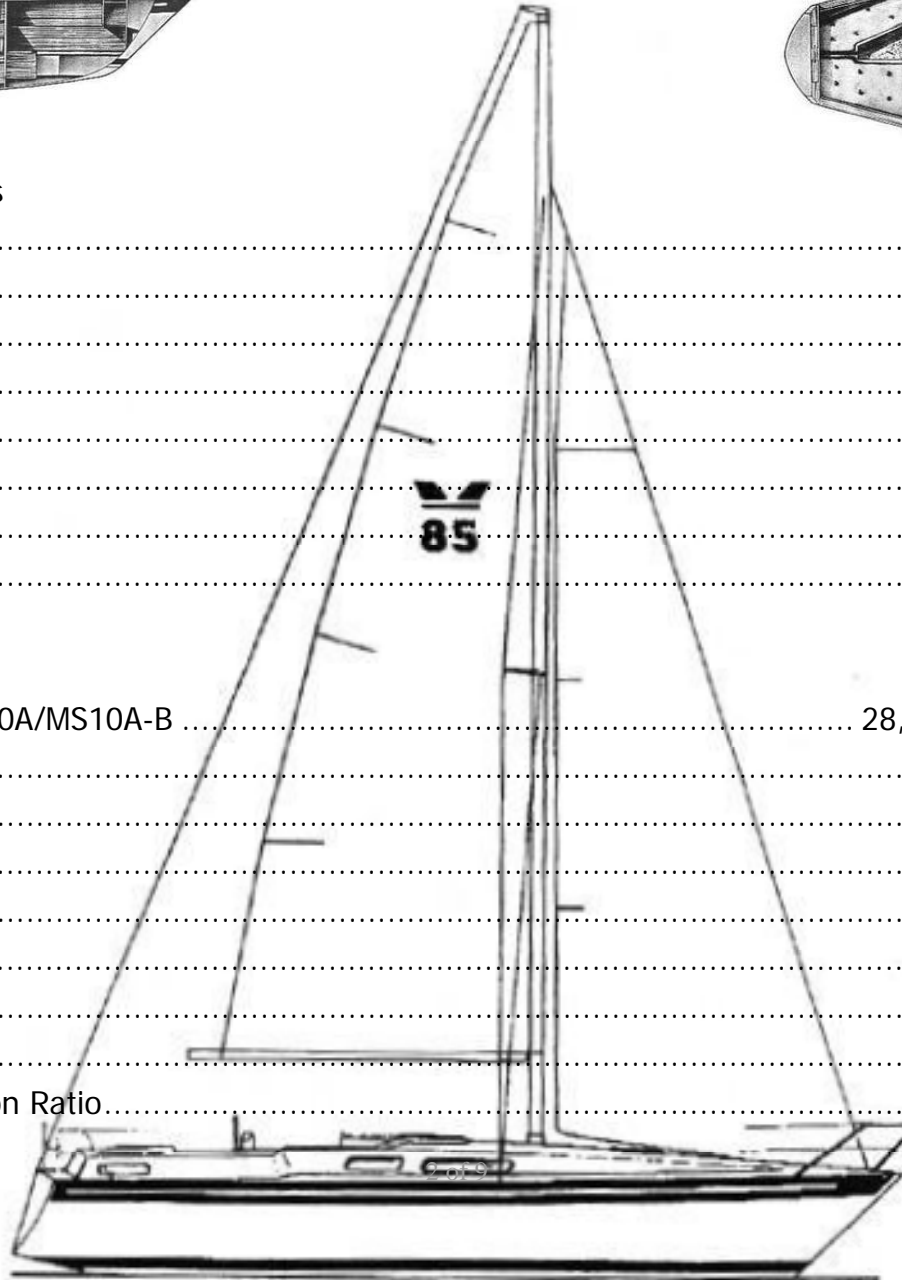

----- Isabelle -----

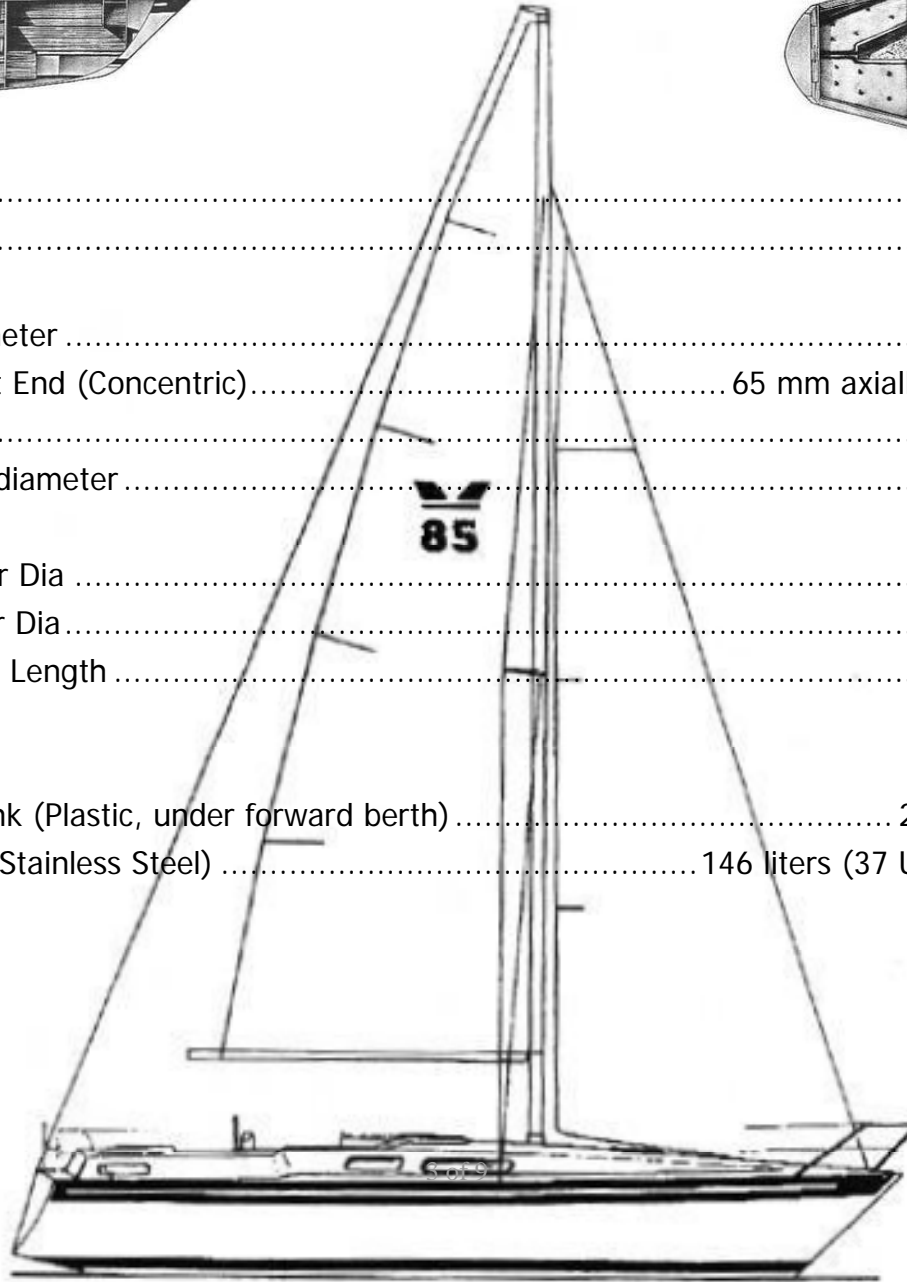
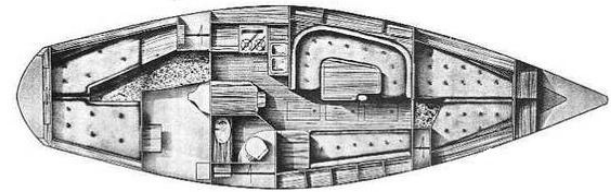
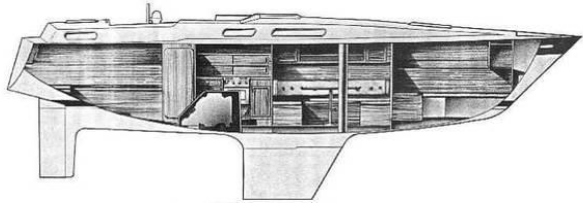

- j. Generator 14V/115 Amp
- k. Starter Motor 2,7 Hp (2,0kW)
- l. Propeller shaft
 - i. Diameter 25,00 mm
 - ii. Shaft End (Concentric)..... 65 mm axially and 25-22 mm radially
 - iii. Key 55x10 and 6 mm thick
- m. Stern tube outer diameter 43 mm
- n. Cutlass bearing
 - i. Outer Dia 1,50 inch
 - ii. Inner Dia 25,00 mm
 - iii. Total Length 4 inch
- 4. Fluid Quantities
 - a. Potable Water tank (Plastic, under forward berth) 233 liters (60 US gallons)
 - b. Diesel Fuel tank (Stainless Steel) 146 liters (37 US gallons) 45x50x65 cm

----- Isabelle -----

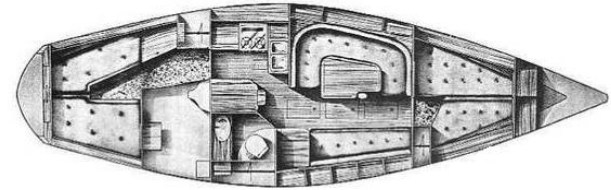
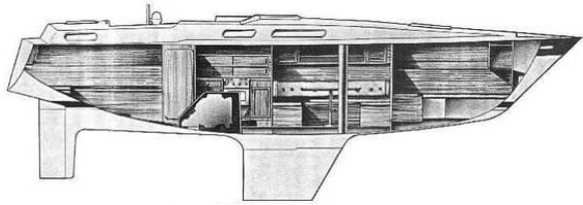

5. Standing Rig

- a. Forestay 7 mm
- b. Top shroud 7 mm Turnbuckle 1/2"
- c. Lower shroud 10 mm Turnbuckle 5/8"
- d. Aft stay 5 mm
- e. Aft stay Sheaf 3/16"

6. Running Rig

- a. Genoa Halyard Rope 3/8" Wire 3/16"
- b. Main Halyard Rope 3/8" Wire 3/16"

7. Mainsail Mast Track Plastic.

- a. 34mm height
- b. 18mm width
- c. 3mm thick 21mm total thickness.

8. Hatches and Portlights

- a. 2

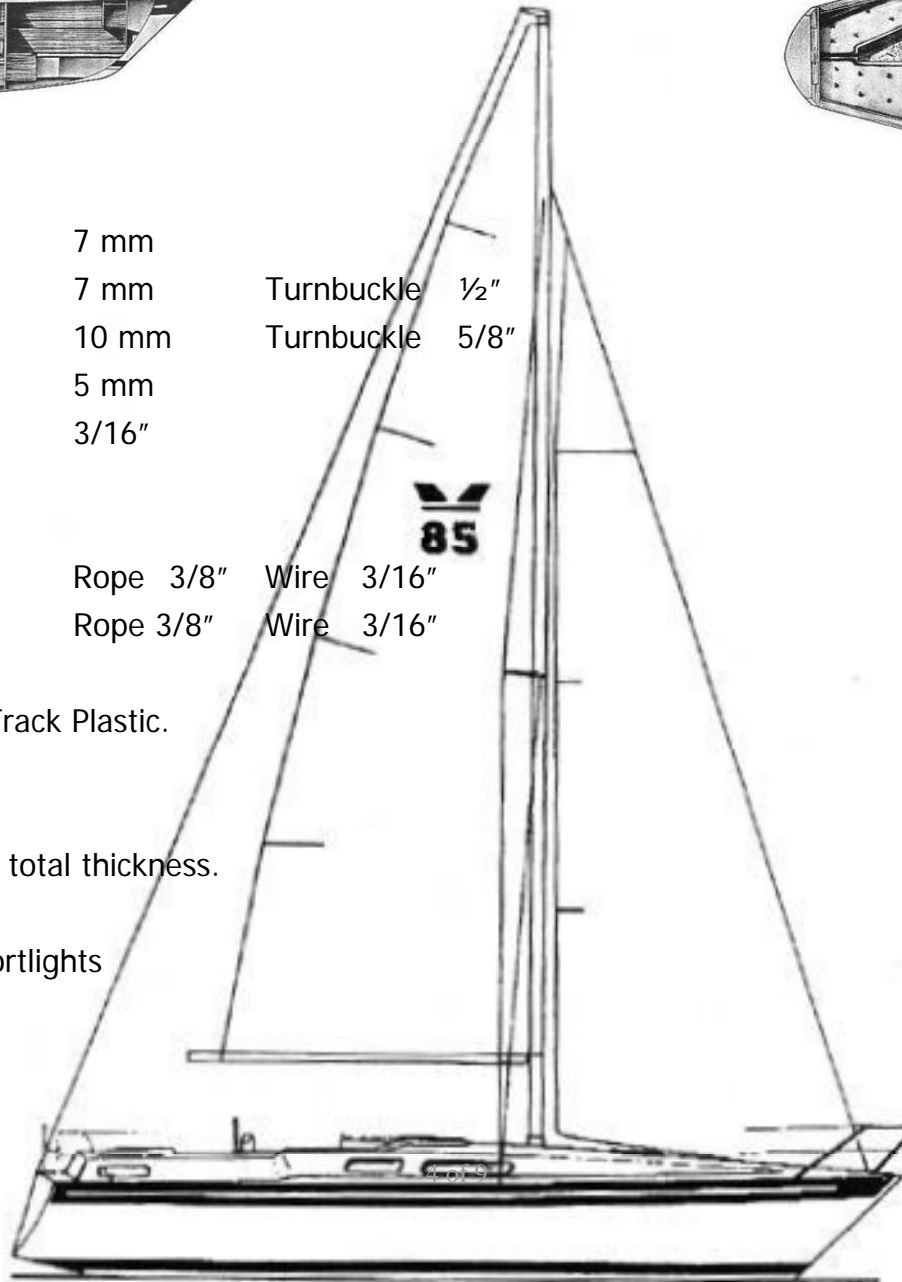

----- Isabelle -----

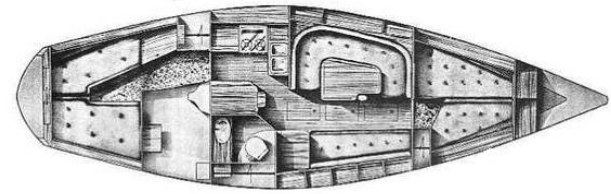
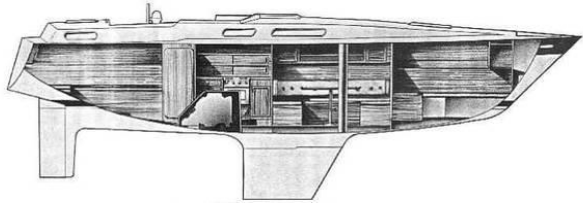

Isabelle Equipment Inventory

| | | Year |
|----------------------|--|---------------------|
| 1. Safety | | |
| a. | Radar reflector Firdell Blipper 210-7..... | 2004 |
| b. | Bilge Pump Jabsco 50 lit/min | 2004 |
| c. | Bilge Pump Jabsco Submergible 125 lit/min..... | 2004 |
| d. | New Chain plates | 2004 |
| 2. Navigation | | |
| | Power Consumption | |
| a. | Raymarine RL70C Plus HSB ² 7" (E52033)..... | 9 W2002 |
| b. | Raymarine Plotter RC530 HSB 7" (E32035) | 9 W2003 |
| c. | Raymarine Pathfinder Antenna 2kW 18"..... | 9,0/28 W2004 |
| d. | Raymarine ST4000 MkII Plus (E12053) | 0,72/10 W2004 |
| e. | Raymarine ST40 Rotovecta Wind (E22047) |2005 |
| f. | Raymarine ST40 Bidata (E22045) |2004 |
| g. | Raymarine Raystar SDGPS 120 WAAS (E32025)..... | 1,5 W2004 |
| h. | Raymarine PC-SeaTalk-NMEA Interface Box (E85001) |2004 |
| i. | Interphase Forwarding looking Scanner |2004 |
| j. | Plastimo Compass 135 Baltic..... |2004 |
| k. | JRJ Athena Electronic Heading Sensor 10Hz |2005 |

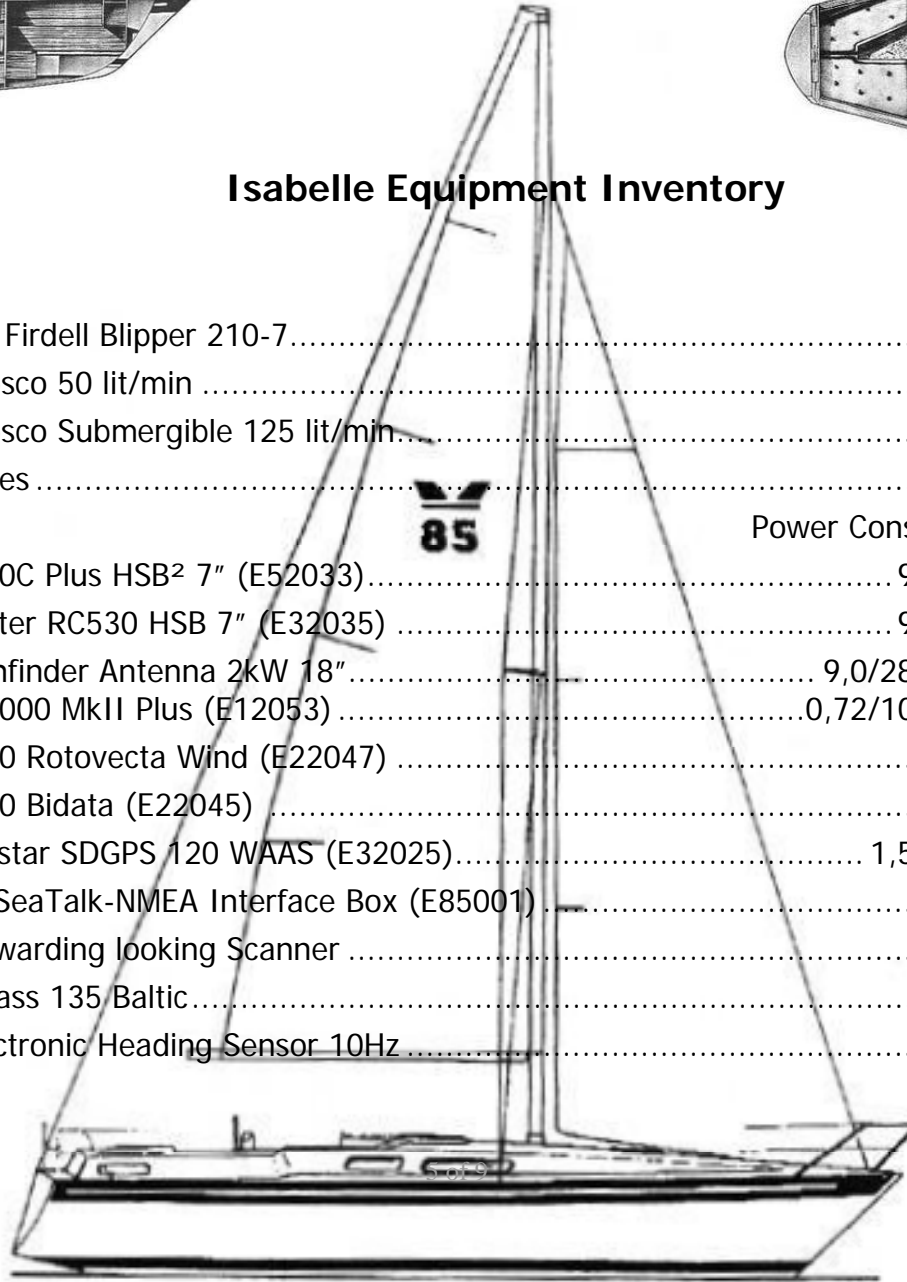

----- Isabelle -----

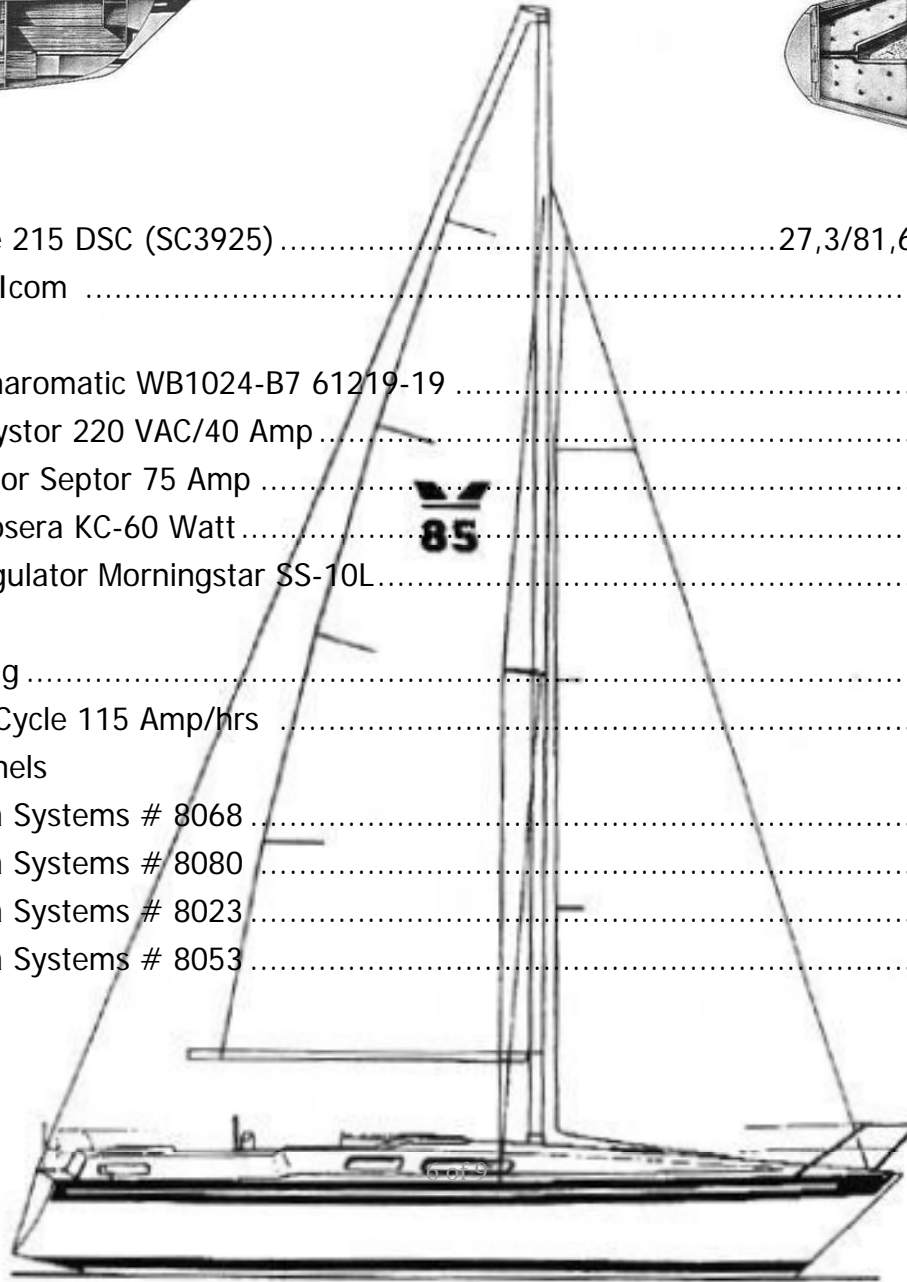
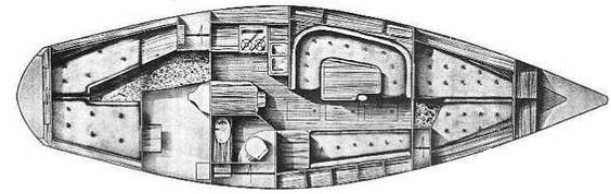
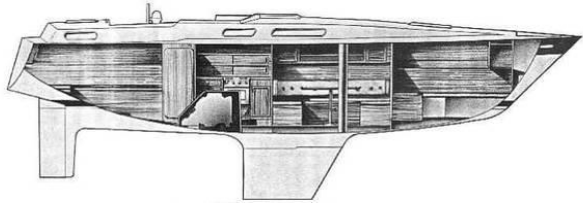

3. Communication

- a. VHF Raymarine 215 DSC (SC3925)27,3/81,6 W2004
- b. VHF Handheld Icom2004

4. Electrical

- a. Winchlass Ancharomatic WB1024-B7 61219-191996
- b. Shore power Tystor 220 VAC/40 Amp2004
- c. Battery separator Septor 75 Amp2004
- d. Solar panel Kyosera KC-60 Watt2004
- e. Solar panel Regulator Morningstar SS-10L2004
- f. Batteries
 - i. 1 Starting2004
 - ii. 2 Deep-Cycle 115 Amp/hrs2004
- g. Distribution Panels
 - i. Blue Sea Systems # 80682004
 - ii. Blue Sea Systems # 80802004
 - iii. Blue Sea Systems # 80232004
 - iv. Blue Sea Systems # 80532004

----- Isabelle -----

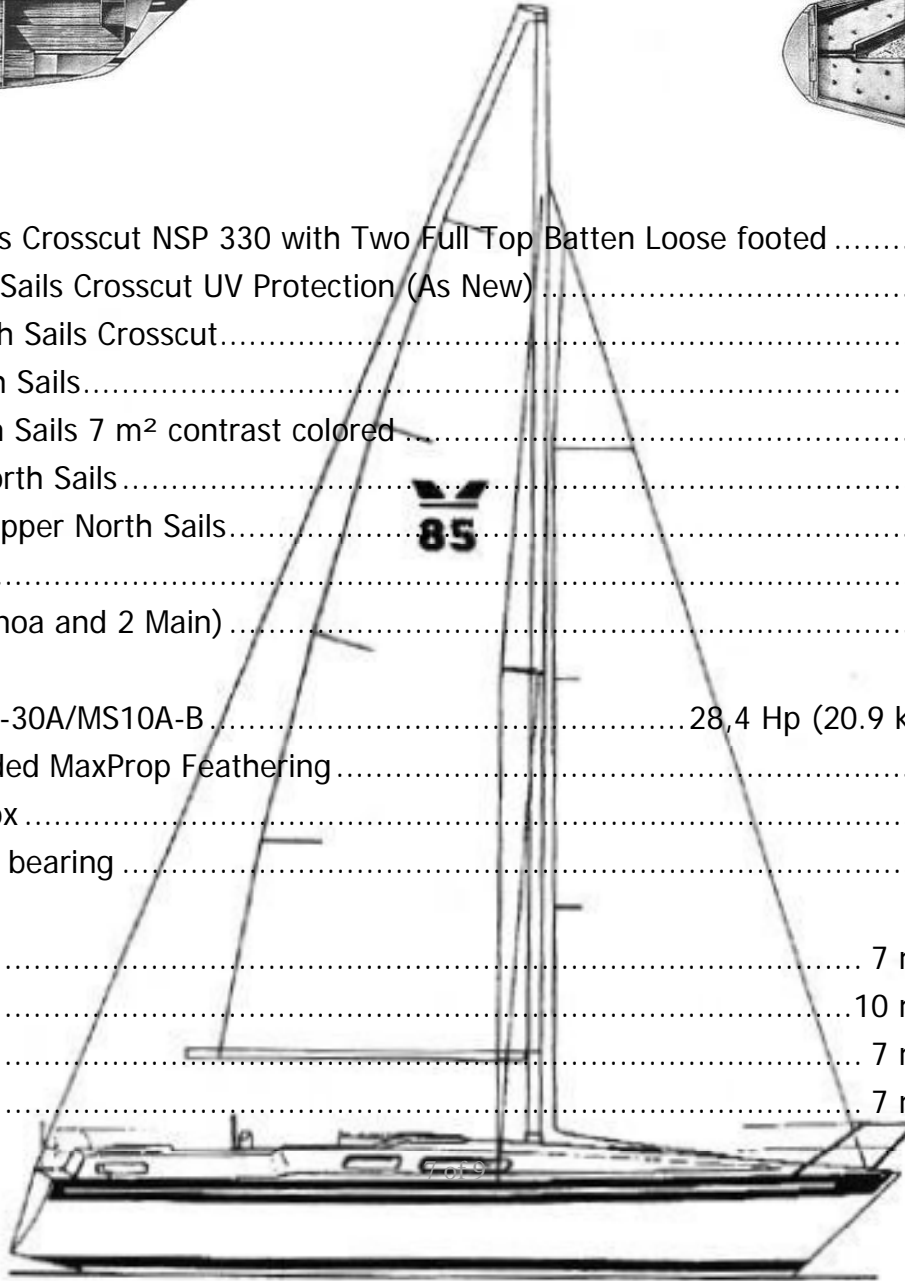
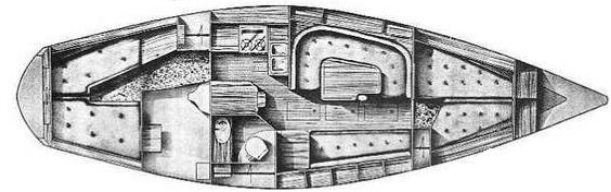
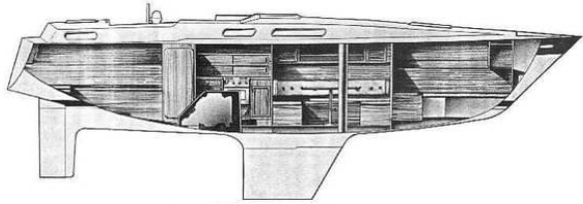

5. Sails and Canvases

- a. Main North Sails Crosscut NSP 330 with Two Full Top Batten Loose footed2004
- b. Genoa 1 North Sails Crosscut UV Protection (As New)2000
- c. Jib 109 % North Sails Crosscut.....2006
- d. Gennaker North Sails.....2005
- e. Storm Jib North Sails 7 m² contrast colored2004
- f. Boom Cover North Sails.....2004
- g. Jib Sleeve w/ zipper North Sails2005
- h. Bimini top.....1995
- i. Halyards (2 Genoa and 2 Main)2004

6. Propulsion

- a. Volvo Penta D1-30A/MS10A-B 28,4 Hp (20.9 kW)2006
- b. Propeller 2 Bladed MaxProp Feathering2004
- c. PSS Stuffing Box2004
- d. Caravel Cutlass bearing2004

7. Rig

- a. Top Shroud 7 mm2006
- b. Lower Shroud 10 mm2004
- c. Forward Stay 7 mm2007
- d. Aft Stay..... 7 mm2006

----- Isabelle -----

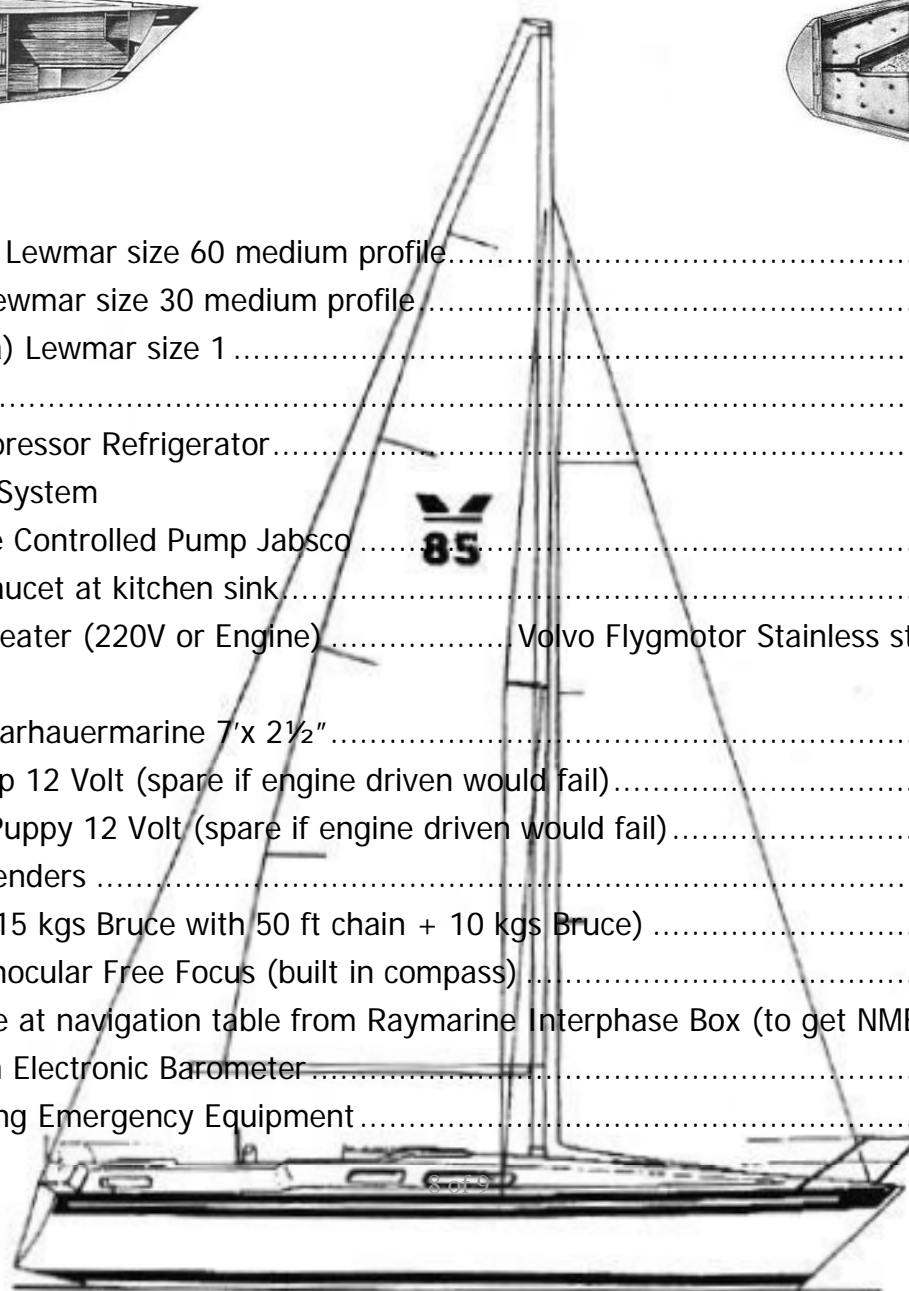
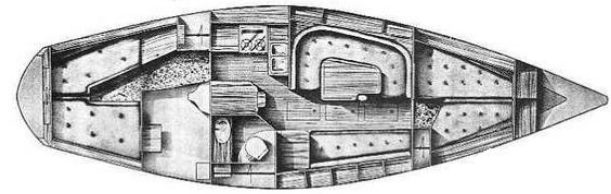
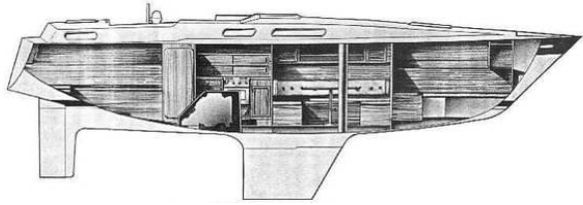

8. Cabin & Pantry

- a. Hatches (2 ea) Lewmar size 60 medium profile.....2006
- b. Hatch (1 ea) Lewmar size 30 medium profile.....2006
- c. Portlights (6 ea) Lewmar size 12007
- d. Propane Owen.....1985
- e. Isotherm Compressor Refrigerator.....2001
- f. Potable Water System
 - i. Pressure Controlled Pump Jabsco.....2004
 - ii. Water faucet at kitchen sink.....2004
 - iii. Water Heater (220V or Engine)..... Volvo Flygmotor Stainless steel1985

9. Additional Equipment

- a. Radar Tower Garhauermarine 7"x 2 1/2"2004
- b. Holly Fuel Pump 12 Volt (spare if engine driven would fail).....2004
- c. Jabsco Water Puppy 12 Volt (spare if engine driven would fail).....2000
- d. 6 ea Danfort Fenders2004
- e. 2 ea Anchors (15 kgs Bruce with 50 ft chain + 10 kgs Bruce) ?
- f. 1 ea Marine Binocular Free Focus (built in compass).....2000
- g. Computer cable at navigation table from Raymarine Interphase Box (to get NMEA into Notebook)
- h. Weems & Plath Electronic Barometer.....2004
- i. Several Signaling Emergency Equipment.....2004

----- Isabelle -----

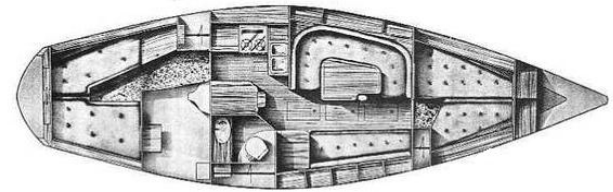
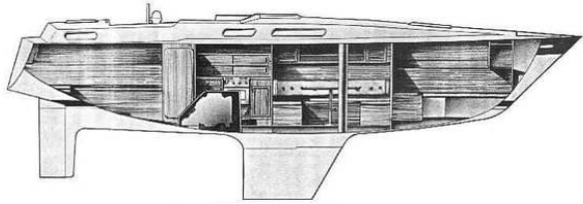

- j. 4 ea Strobe lights for personal use at night2005
- k. 1 ea MagLite Flashlight (6 Type D Batteries)2003
- l. Emergency Steering Tiller, to be inserted thru the roof in aft cabin1985

